

Online Journal of Space Communication

Volume 1
Issue 2 *NASA's Advanced Communications
Technology Satellite [ACTS] (Fall 2002)*

Article 13

September 2002

Special Effects: Antenna Wetting, Short Distance Diversity and Depolarization

Roberto J. Acosta

Follow this and additional works at: <https://ohioopen.library.ohio.edu/spacejournal>



Part of the [Astrodynamics Commons](#), [Navigation, Guidance, Control and Dynamics Commons](#), [Space Vehicles Commons](#), [Systems and Communications Commons](#), and the [Systems Engineering and Multidisciplinary Design Optimization Commons](#)

Recommended Citation

Acosta, Roberto J. (2002) "Special Effects: Antenna Wetting, Short Distance Diversity and Depolarization," *Online Journal of Space Communication*: Vol. 1 : Iss. 2 , Article 13.

Available at: <https://ohioopen.library.ohio.edu/spacejournal/vol1/iss2/13>

This Article is brought to you for free and open access by the OHIO Open Library Journals at OHIO Open Library. It has been accepted for inclusion in Online Journal of Space Communication by an authorized editor of OHIO Open Library. For more information, please contact debord@ohio.edu.

Special Effects: Antenna Wetting, Short Distance Diversity and Depolarization

Roberto J. Acosta

NASA Glenn Research Center, Cleveland, Ohio 44135

Phone: 216-433-6640, Fax: 216-433-6371. E-mail: Roberto.J.Acosta@grc.nasa.gov

Abstract- The Advanced Communication Technology Satellite (ACTS) communications system operates in the Ka frequency band. ACTS uses multiple, hopping, narrow beams and very small aperture terminal (VSAT) technology to establish a system availability of 99.5% for bit-error-rates of 5×10^{-7} or better over the continental United States. In order to maintain this minimum system availability in all US rain zones, ACTS uses an adaptive rain fade compensation protocol to reduce the impact of signal attenuation resulting from propagation effects. The purpose of this paper is to present the results of system and sub-system characterizations considering the statistical effects of system variances due to antenna wetting and depolarization effects. In addition the availability enhancements using short distance diversity in a sub-tropical rain zone are investigated.

I. Introduction

The Advanced Communications Technology Satellite (ACTS) was launched in September 1993 and is now operating in inclined orbit of 0.8 degrees per year. The primary objective of the technology verification experiment (TVE) program is to obtain a deeper understanding and full statistical characterization of ACTS Ka band sub-systems. These measurements, obtained in an operational space environment, are needed to accurately evaluate ACTS technology and to promote the development and characterization of prototype Ka band sub-system technologies.

This paper describes two propagation effects and a rain fade compensation technique that should be considered when designing a Ka-band satellite system. The contribution of wet reflector antennas and depolarization to the signal path losses in a Ka-band, low margin system is statistically documented. Two-station diversity is experimentally investigated in a sub-tropical rain zone.

The amount of water in ground reflector antennas (reflector and feed radomes) can cause additional signal loss (up to 4 to 5dB) from the expected propagation attenuation due to rain at Ka-band. This is one reason that the standard techniques for predicting rain fade statistics (using propagation models) are not aligned with ACTS Ka-band RF beacon measurements.

All ACTS ground reflectors, including the propagation terminal (APT) utilized off-the-shelf hardware that was mainly designed for Ku-band operations. The ACTS reflector surfaces were coated with a very thick and rugged dielectric layer, that in the presence of water, created a large reflection coefficient causing larger (2-5 dB) attenuation of the signal.

The problem of wet antenna can be described as high perturbation on the feed standing wave ratio. In contrast, the reflector losses can be explained by an additional scattering losses and absorption due to raindrops' size at the surface of the reflector. Borsholm, Crane and Acosta [1,2,3] have studied the problem of signal loss due to wet reflector antenna and radome surfaces. In this paper, extensive measurements are presented to statistically characterize the wetting effect.

Rain induced depolarization is produced from a differential attenuation and phase shift caused by non-spherical raindrops. As the size of raindrops increase, their shape tends to change from spherical (the preferred shape because of surface tension forces) to oblate spheroids with an increasingly pronounced flat or concave base produced from aerodynamic forces acting upward on the drops.

A second source of depolarization on an Earth-space path, in addition to rain, is the presence of ice crystals in clouds at high altitudes. Ice crystal depolarization is caused primarily by differential phase shift rather than differential attenuation, which is the major mechanism for raindrop depolarization. Ice crystal depolarization can occur with little or no co-polarized attenuation. The amplitude and phase of the cross-polarized component can exhibit abrupt changes with large excursions.

Atmospheric depolarization effects were measured using the ACTS beacons and collected for $\frac{1}{2}$ of a station year. Depolarization due to rain is not an issue at Ka-band since the cross-pol and co-pol signals are attenuated by the same amount; therefore making the system margin a dominant function of the co-pol attenuation. Another depolarization effect is due to ice crystals. This depolarization phenomenon is characterized by an increase of cross-pol level and a small but negligible co-pol attenuation. Experimental data using the ACTS beacon at 20.185 GHz showed that the cross-pol can increase by 10 dB with negligible co-pol attenuation. This effect is important when designing polarization reuse, and multiple beam systems at Ka-band.

Spatially diversified ground stations must be close enough to minimize the cost of connecting terrestrial lines, but still realize an increase in link availability. By utilizing the signal from whichever station is experiencing the least attenuation, the overall link availability is increased. Site diversity is a method for increasing the system availability at the expense of adding at least one more ground station. In tropical and sub-tropical rain zones the rain cells are compact (<10-km) therefore implying that short distance diversity might be employed. The data collected in this investigation use two-station diversity geometry with a separation distance of 1.2 km. The experiment shows typical diversity gain of 5 to 10 dB. These measurements clearly establishes a method for compensating rain fades in a sub-tropical rain zones.

The primary objective of this paper is to experimentally determine the magnitude of the signal loss when the ACTS antenna reflector is wet, depolarization effects on cross-pol, and gain enhancement of short distance diversity in a sub-tropical rain zone.

II. Experiment Description

Antenna Wetting Experiment - The objective of the antenna wetting experiment consisted in measuring the magnitude of the effect and its correlation to rain rate for the ACTS 0.6-m Ultra Small Aperture Terminal (USAT) reflector antenna. **Figure 1.** describes the outdoor experiment set-up. It consisted into two identical reflector systems located side-by-side, one reflector was protected from rain and the other exposed to rain. The protected reflector is covered everywhere except in the aperture plane. The received continuous wave 20 GHz RF signal is digitally recorded at _ sec sampling rate and filtered at 40 kHz with a bandpass filter centered at 70 MHz. The receiver has a signal to noise ratio of at least 30 dB, therefore fades up to 30 dB can be recorded without distortion.

The antenna-wetting factor is defined as the difference between the dry reflector signal and the wet reflector. In addition to measuring the signal power, a small weather station is operated next to the USAT terminals. Rainfall data are collected using a tipping bucket rain gage. The experiment was located in sub-tropical region in Cocoa, Florida. The data collection period extended between April 1999 to April 2000.

Depolarization Experiment - The objective of the depolarization experiment consisted of measuring the magnitude of the received beacon cross polarization signal in wet and dry conditions. **Figure 2a.** depicts the experiment outdoor unit and **Figure 2b.** describes the system block diagram. The experiment terminal is a modified ACTS propagation terminal (APT) with a 4 channel, dual polarization receiver. The experiment was located in medium rain zone region in Ahburn, Virginia. The data collection period extended between August to December 1999.

The hardware modifications made to original APT RF enclosure were basically to remove the 27 GHz components and replace them with 20 GHz components. Within each receiver enclosures are the co-pol and cross-pol IF. The digital receivers are configured so that the co-pol units are the master subassemblies at the physical location of the original APT 20 GHz hardware and the cross-pol are the slave subassemblies at the physical location of the original APT 27 GHz hardware. The significance of this is that the master subassemblies provide the fixed 65 MHz 2nd LO and 3rd LO (~4.54 MHz) from digital receiver and the digital receiver clock to slave subassemblies.

Several modifications were made to the original APT data collection software to accomplish the measurement goals and to accommodate the hardware modification.

Short Distance Diversity Experiment - The objective of the short distance experiment consisted of measuring the magnitude of site diversity gain using two ACTS APT 1.2-m VSAT reflector antenna separated by 1.2-km. **Figure 3a.** describes the experiment outdoor units during checkout and **Figure 3b.** shows a block diagram of the APT. The experiment was located in sub-tropical region in Tampa, Florida. The data collection period extended between September 1999 to December 1999.

The experiment consisted of locating two identical propagation terminals separated by a distance of 1.2 km. The propagation terminals are capable of tracking and receiving the

ACTS beacons at 20 and 27 GHz co-polarized beacon signals. The terminals also measured the sky noise temperature close to the beacon frequencies. This allows the elimination of equipment effects from the measured beacon signal levels and accurate isolation of propagation effects during post processing of the collected data. Most of the RF hardware used in the terminals is identical. The APT uses digital receiver technology. In addition to the beacon signals, several meteorological parameters are recorded at the two sites. These include rain intensity, ambient temperature, humidity and pressure. The auxiliary parameters are useful in calibrating the radiometer channels and interpreting the propagation results.

III. Experiment Results

Antenna Wetting Experiment- This paper discusses the impact of signal loss as a result of water layer on the USAT antenna reflector surfaces and the antenna feed horn radomes. The measured impact of wet antennas proved to be significant. **Figure 4a.** shows the cumulative distribution function (CDF) of two station years for the antenna-wetting factor. **Figure 4b.** presents the tipping bucket rain rate CDF for the site and notice that it describes a typical sub-tropical region behavior. Notice the antenna-wetting factor exceeds 2.5 dB for 10 % of the time. At this percent of time rain rates are greater than 90 mm/hr, which is considered extremely heavy rain. At low rain rates (< 5 mm/hr) the antenna-wetting factor is about 1 dB.

In order to minimize the effect of wet reflectors the dielectric thickness of the reflector needs to be minimized to reduce the losses in the presence of a water layer. The feed radome can be easily covered on the topside to protect the phased center of the horn from being exposed to water. If an extended radome is used, careful offset design needs to be used in order to prevent signal loss or blockage loss.

Depolarization Experiment - The experiment studied the effect of the cross-polarization signal in rainy and faded conditions. **Figure 5.** depicts the two orthogonal components CDF's. The antenna misalignment effects can be seen from the dry CDF. Notice there is an increase of cross-pol signal for about 0.1 % of the time. We can infer that this is due to ice-depolarization since it is the only probable cause for increase of cross-pol signal under faded conditions when compared to dry or clear sky conditions. Also from **Figure 5.** it can be seen that both components increase by about the same amount, therefore confirming the expectation that ice-depolarization is non-polarized event. The data contains a total of about 7 weeks of clear sky and about 2 weeks of faded conditions. In order to make a complete assessment of depolarization due to ice, a complete set of amplitude and phase measurements are required with at least one year of data collection.

Although the experiment goals were met, future work is still required for a complete statistical characterization of the ice-depolarization. For system design the effect of ice-depolarization appears to be small (~0.1 % of total time the signal was faded) and only needs to be considered in polarization reuse systems.

Short Distance Diversity- This experiment documents the gain enhancement that can be obtained in sub-tropical rain zone when using 2 stations separated by a distance of 1.2 km. *Figure 6a.* shows the corresponding CDF for the sites at both 20 GHz and 27 GHz. Notice that they are very close over the useful fade range of 20 dB. The diversity gain is defined in this experimental study as the difference in fade observed simultaneously by the two stations. *Figure 6b.* presents the CDF for the gain at 20 and 27 GHz. Notice that 27 GHz gains are larger than expected at 20 GHz. Gain enhancement exceeding 10 dB occurs at about 5% of time. A typical expected enhancement of greater than 5 dB is more likely to be achievable in systems operating in tropical and sub-tropical regions.

This experiment documents the boundaries for what is achievable in two-station diversity in the sub-tropical region. To complete the characterization of short distance diversity, a more extensive data set needs to be collected and station separation needs also to be investigated.

VI. References

- [1] Atle Borsholm, "Modeling and Experimental Validation of the Surface Attenuation Effects of Rain on Composite Antenna Structure at Ka-Band", May 1999, NMSU-ECE-99-004.
- [2] R. Crane, "Wet Antenna Studies," 10th ACTS Propagation Studies Workshop (APSW X)", Boca Raton, Florida, September 1997
- [3] R. Acosta, "Wet Antenna Effect on Ka-Band Low Margin Systems", 4th Ka Band Utilization Conference, Nov. 2-4, 1998, Venice, Italy
- [4] H. Helmken, J. Duvall and R. Henning, "ACTS Ka-Band Diversity Measurements in Florida", National Radio Science Meeting, Boulder, Colorado, 4-8 January 1999.
- [5] C. Emrich, "ACTS Ka-Band Propagation Research in Spatially Diversified Network With Two USATs", Final Contract report, FSEC-CR-1090, May 25, 1999.

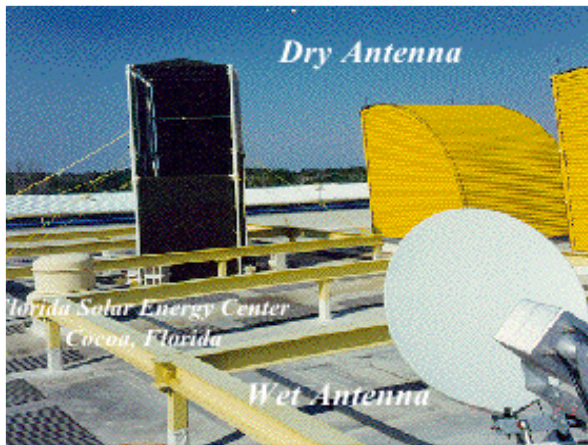

Figure 1 – Antenna Wetting Units

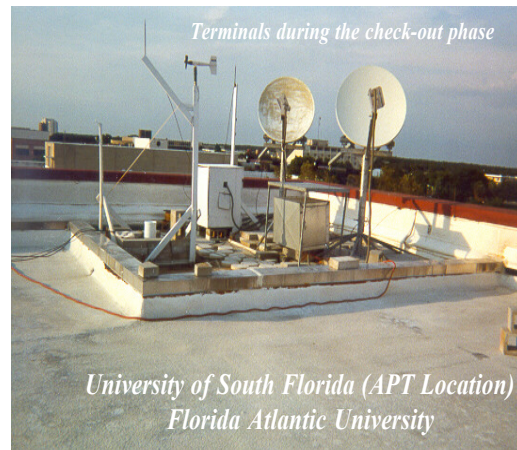

Figure 3a – System Units at Checkout



Figure 2a – Depolarization Unit

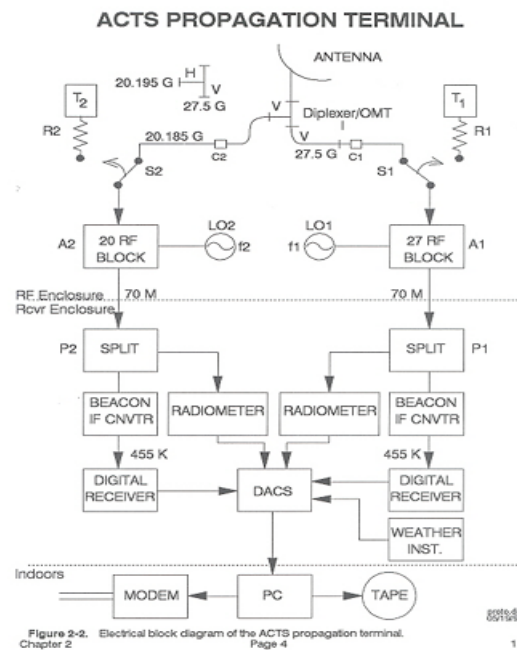

Figure 3b – System Block Diagram of APT

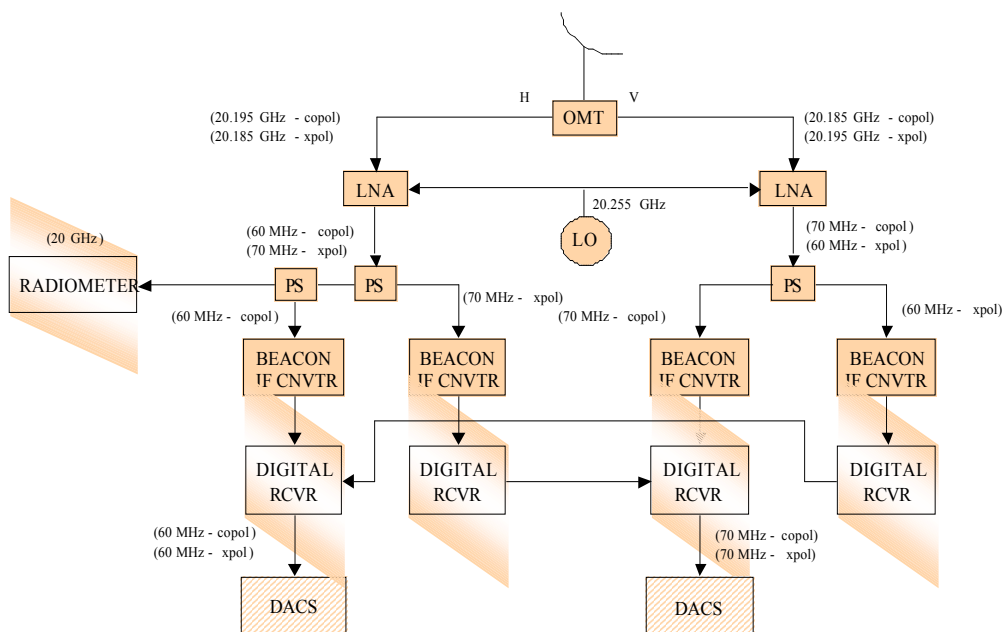

Figure 2b – System block diagram for the modified ACTS propagation terminal

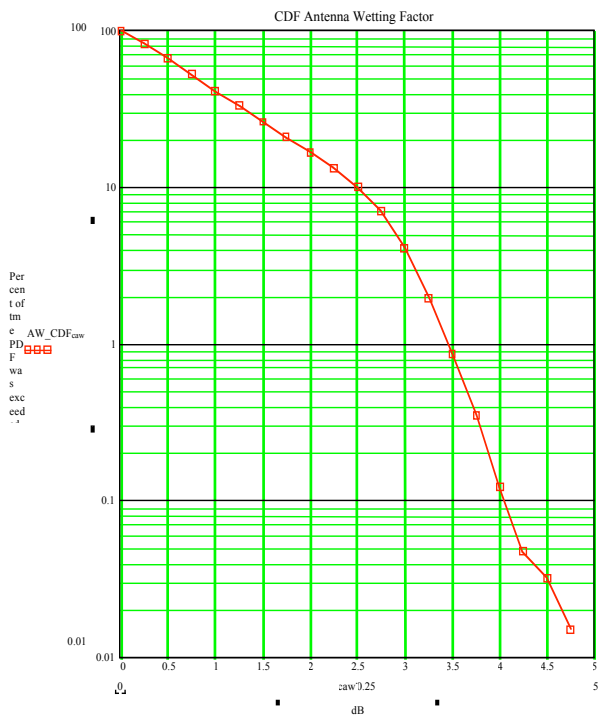

Figure 4b – CDF for antenna wetting factor

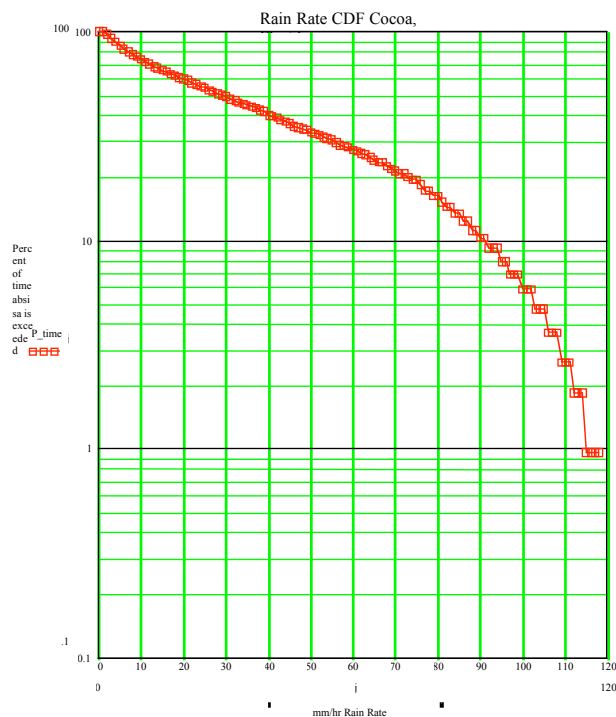

Figure 4c – CDF for the rain rates

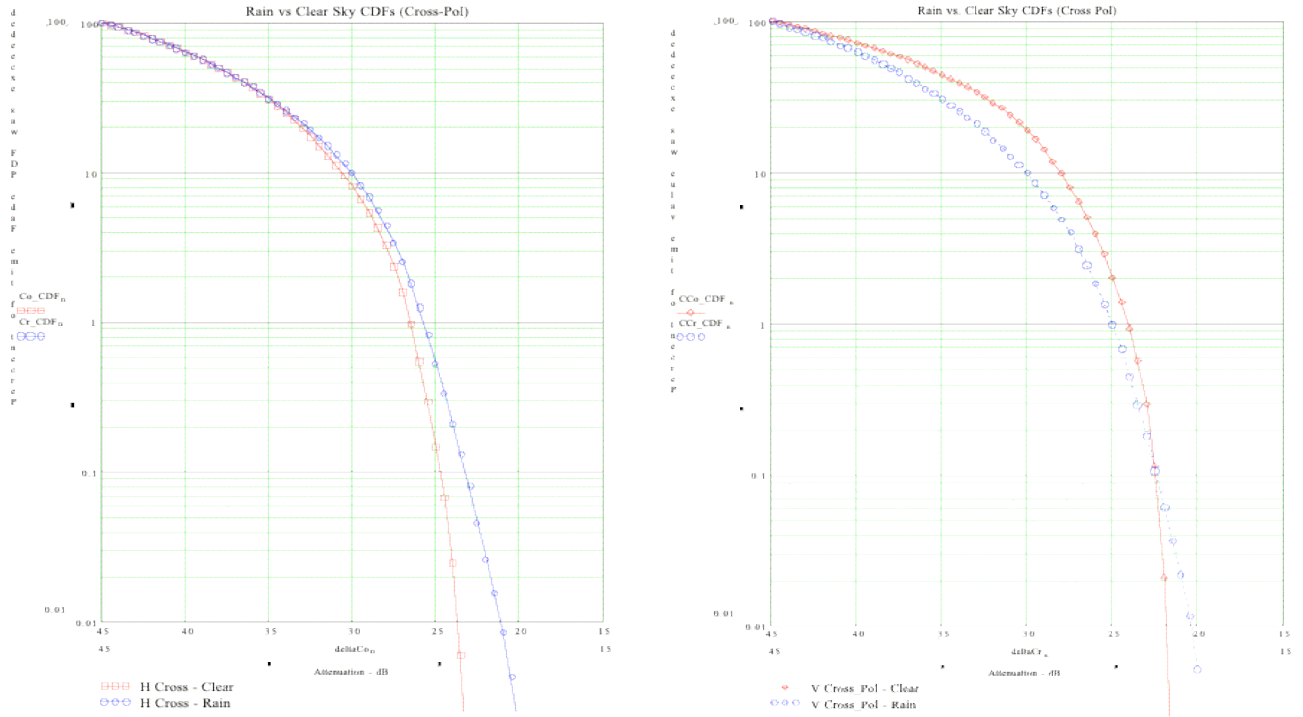

Figure 5 – Cross-Polarization signal Dry vs. Wet

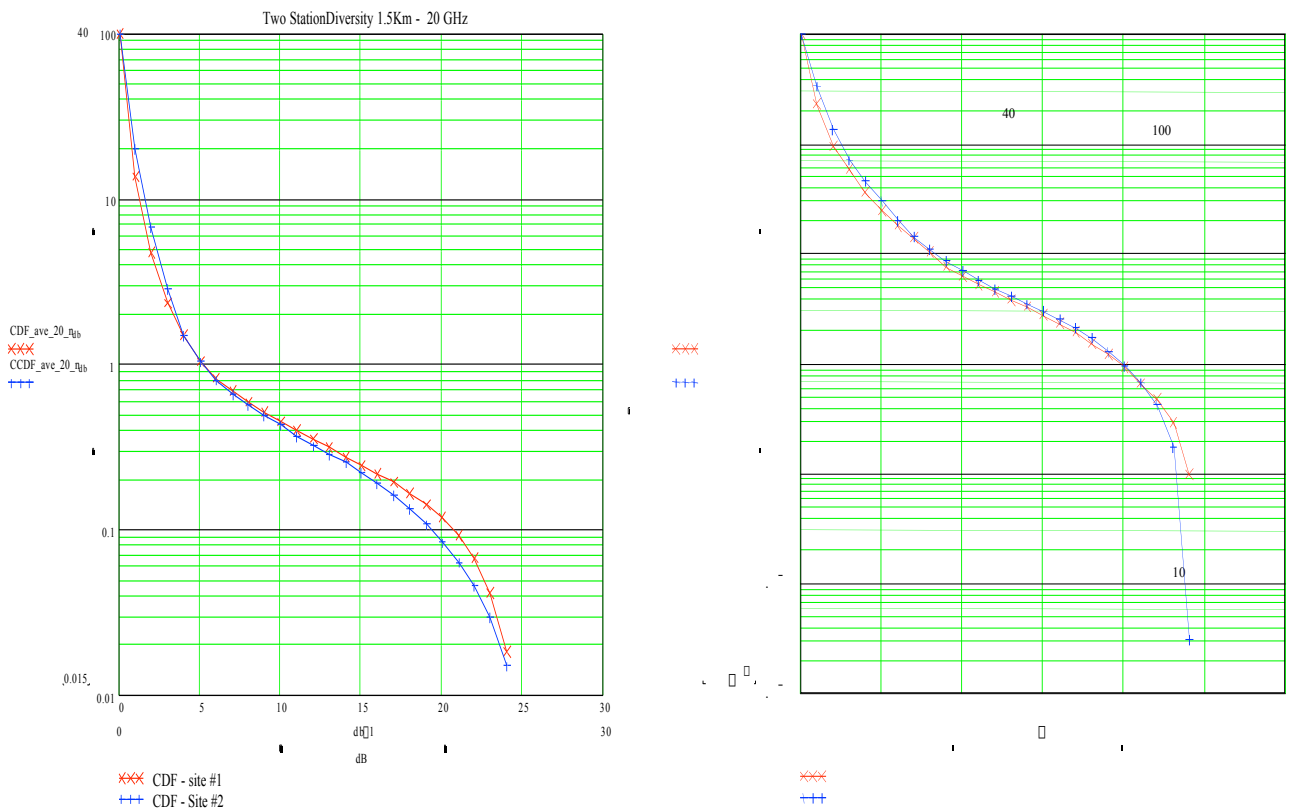

Figure 6a – Attenuation CDFs for both sites and frequencies.

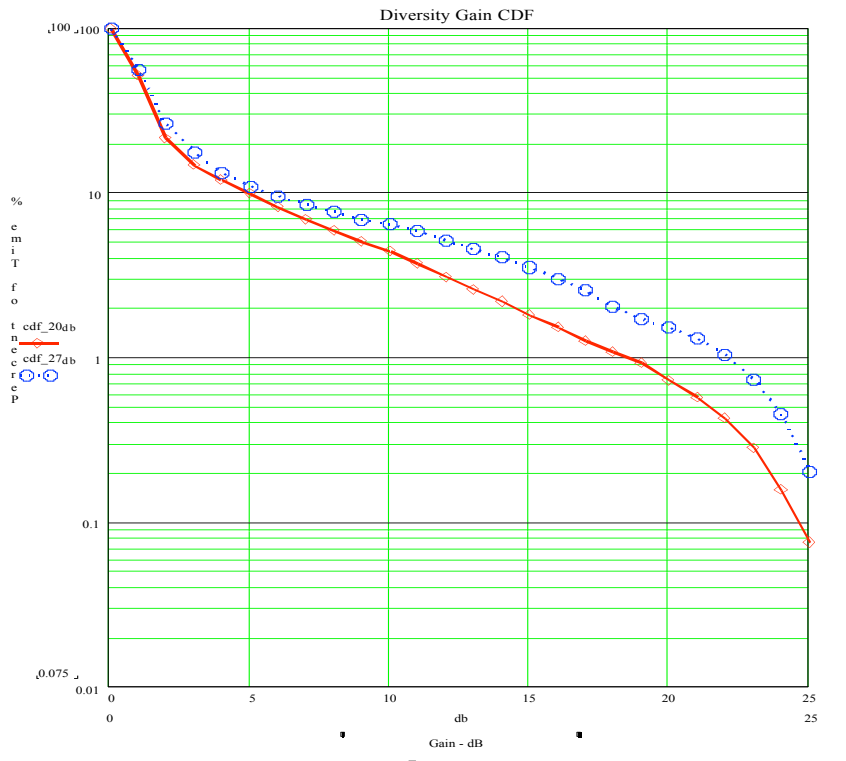

Figure 6b- CDF Site Diversity Gain at 20 GHz and 30 GHz